

Classy Cabinets & Kitchens

QUALITY KITCHEN CABINETS & VANITY UNITS

Classy Cabinets & Kitchens

25 Gasoline Way
 Craigieburn. VIC 3064
 Ph: 9333 8411 Fax: 9333 8422
 E: quotes@classycabs.com.au

Customer Name: PEMBROOK HOMES UNIT-2

Site Address: 23 BELAIR AVENUE GLENROY

BENCH TOP: 40mm Stone
 BASE FINISH: SNOWDRIFT GLOSS
 O/HEAD FINISH: NATURAL OAK MATT
 FEATURE #1 FINISH:
 FEATURE #2 FINISH:
 KICK FINISH:
 HINGE: Hettich Soft Close Hinge

BENCH TOP FINISH: 40MM STONE
 BASE DOOR STYLE: Slab
 O/HEAD DOOR STYLE: Slab
 KICK HEIGHT:
 DRAWER RUNER: DTC DragonPro Wte 40kg
 HANDLE: P-17 BLACK

Designed By: ERGUN

NOT TO SCALE

Design Date: 02/03/23

Page: 1 of 9

CLIENT SIGNATURE OF APPROVAL:

DATE:

DISCLAIMER: All designs *MUST* be signed & dated before production proceeds.

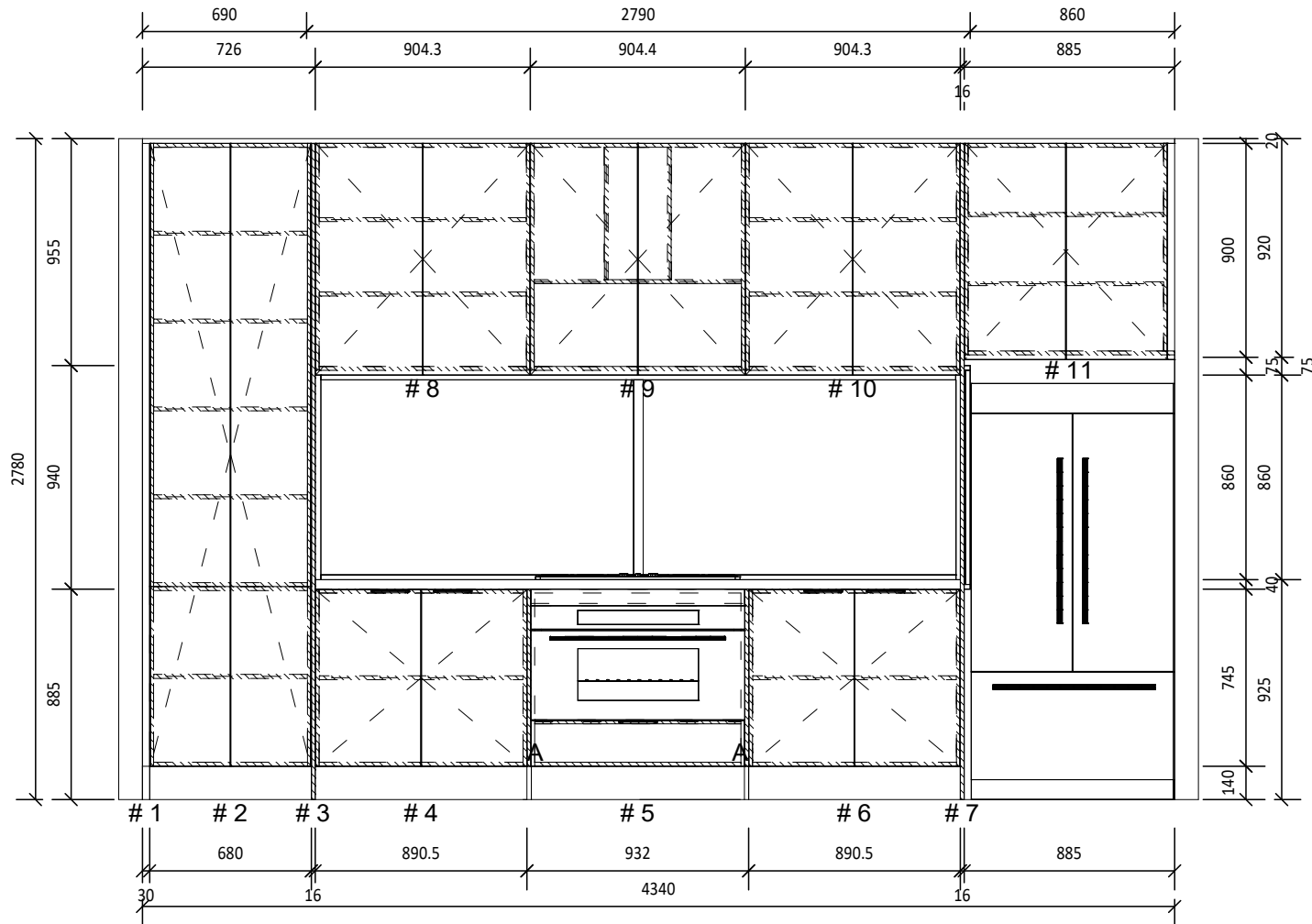

Classy Cabinets & Kitchens

QUALITY KITCHEN CABINETS & VANITY UNITS

Classy Cabinets & Kitchens

25 Gasoline Way
 Craigieburn. VIC 3064
 Ph: 9333 8411 Fax: 9333 8422
 E: quotes@classycabs.com.au

Customer Name: PEMBROOK HOMES UNIT-2

Site Address: 23 BELAIR AVENUE GLENROY

BENCH TOP: 40mm Stone
 BASE FINISH: SNOWDRIFT GLOSS
 O/HEAD FINISH: NATURAL OAK MATT
 FEATURE #1 FINISH:
 FEATURE #2 FINISH:
 KICK FINISH:
 HINGE: Hettich Soft Close Hinge

BENCH TOP FINISH: 40MM STONE
 BASE DOOR STYLE: Slab
 O/HEAD DOOR STYLE: Slab
 KICK HEIGHT:
 DRAWER RUNNER: DTC DragonPro Wte 40kg
 HANDLE: P-17 BLACK

Designed By: ERGUN

NOT TO SCALE

Design Date: 02/03/23

Page: 2 of 9

CLIENT SIGNATURE OF APPROVAL:

DATE:

DISCLAIMER: All designs *MUST* be signed & dated before production proceeds.

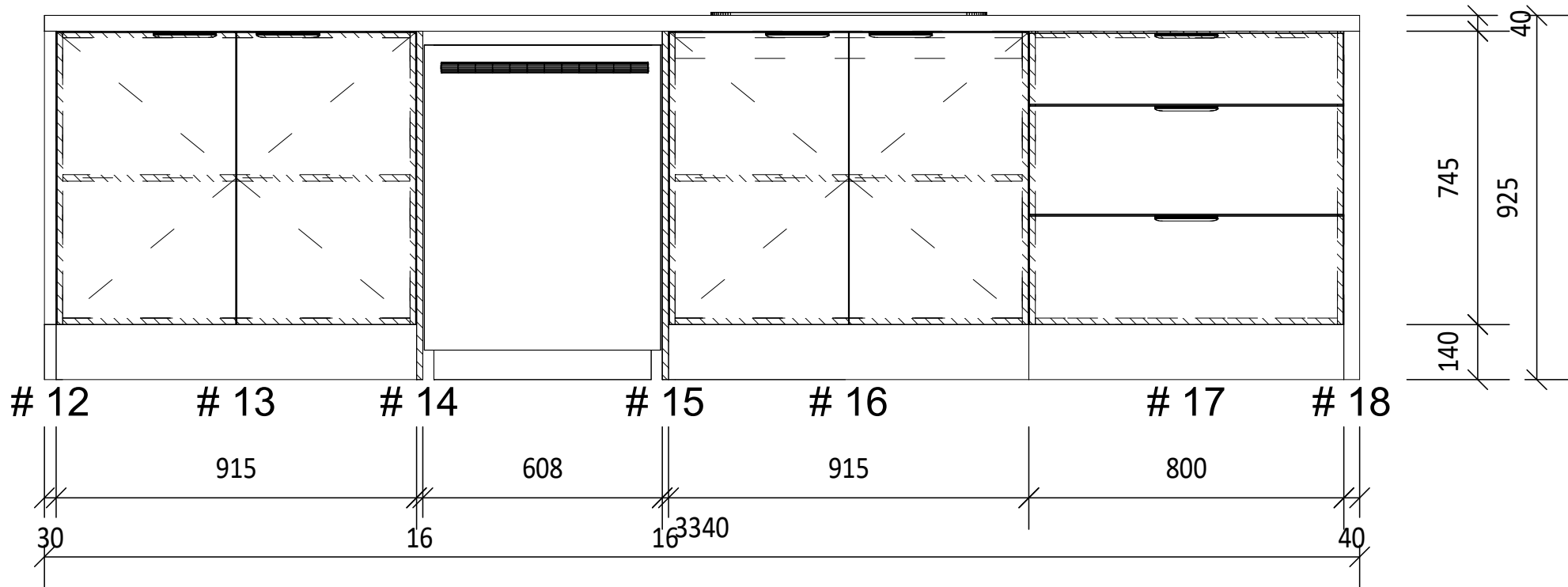

Classy Cabinets & Kitchens

QUALITY KITCHEN CABINETS & VANITY UNITS

Classy Cabinets & Kitchens

25 Gasoline Way
 Craigieburn. VIC 3064
 Ph: 9333 8411 Fax: 9333 8422
 E: quotes@classycabs.com.au

Customer Name: PEMBROOK HOMES UNIT-2

Site Address: 23 BELAIR AVENUE GLENROY

BENCH TOP: 40mm Stone
 BASE FINISH: SNOWDRIFT GLOSS
 O/HEAD FINISH: NATURAL OAK MATT
 FEATURE #1 FINISH:
 FEATURE #2 FINISH:
 KICK FINISH:
 HINGE: Hettich Soft Close Hinge

BENCH TOP FINISH: 40MM STONE
 BASE DOOR STYLE: Slab
 O/HEAD DOOR STYLE: Slab
 KICK HEIGHT:
 DRAWER RUNER: DTC DragonPro Wte 40kg
 HANDLE: P-17 BLACK

Designed By: ERGUN

NOT TO SCALE

Design Date: 02/03/23

Page: 3 of 9

CLIENT SIGNATURE OF APPROVAL:

DATE:

DISCLAIMER: All designs *MUST* be signed & dated before production proceeds.



Classy Cabinets & Kitchens

QUALITY KITCHEN CABINETS & VANITY UNITS

Classy Cabinets & Kitchens

25 Gasoline Way
 Craigieburn. VIC 3064
 Ph: 9333 8411 Fax: 9333 8422
 E: quotes@classycabs.com.au

Customer Name: PEMBROOK HOMES UNIT-2

Site Address: 23 BELAIR AVENUE GLENROY

Designed By: ERGUN

NOT TO SCALE

Design Date: 02/03/23

Page: 4 of 9

REFER TO PLAN VIEW & ELEVATION VIEW FOR SPECIFICATIONS

CLIENT SIGNATURE OF APPROVAL:

DATE:

DISCLAIMER: All designs *MUST* be signed & dated before production proceeds.



Classy Cabinets & Kitchens

QUALITY KITCHEN CABINETS & VANITY UNITS

Classy Cabinets & Kitchens

25 Gasoline Way
 Craigieburn. VIC 3064
 Ph: 9333 8411 Fax: 9333 8422
 E: quotes@classycabs.com.au

Customer Name: PEMBROOK HOMES UNIT-2

Site Address: 23 BELAIR AVENUE GLENROY

Designed By: ERGUN

NOT TO SCALE

Design Date: 02/03/23

Page: 5 of 9

REFER TO PLAN VIEW & ELEVATION VIEW FOR SPECIFICATIONS

CLIENT SIGNATURE OF APPROVAL:

DATE:

DISCLAIMER: All designs *MUST* be signed & dated before production proceeds.

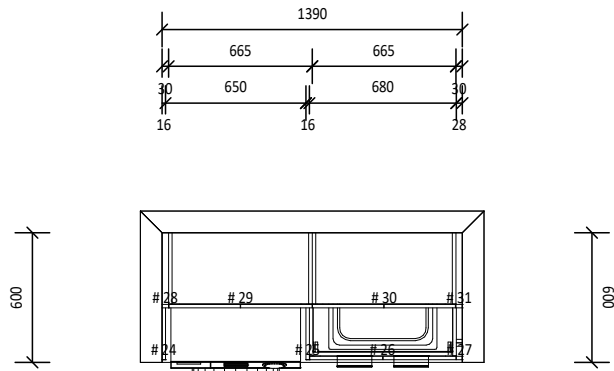

LAUNDRY

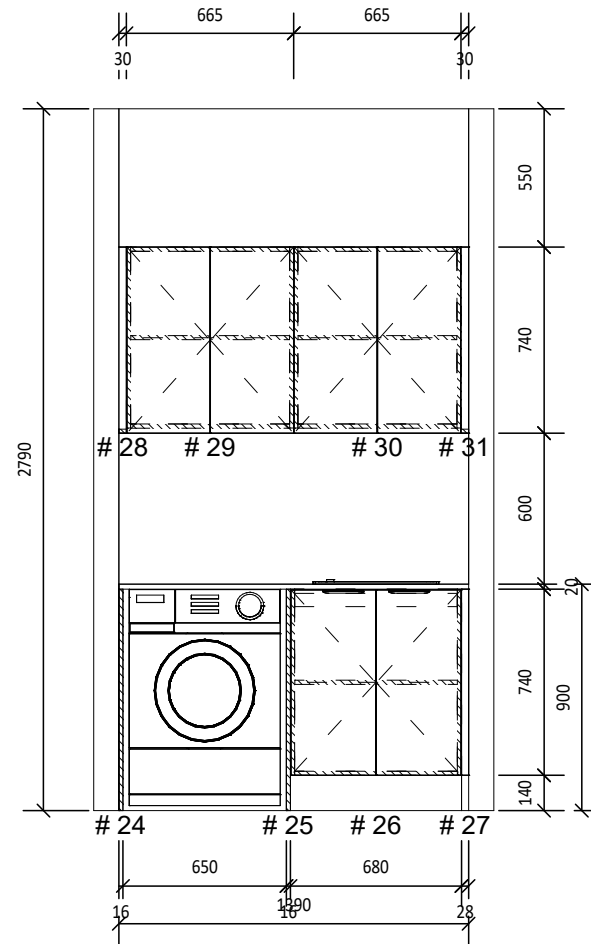

Classy Cabinets & Kitchens

QUALITY KITCHEN CABINETS & VANITY UNITS

Classy Cabinets & Kitchens

25 Gasoline Way
 Craigieburn. VIC 3064
 Ph: 9333 8411 Fax: 9333 8422
 E: quotes@classycabs.com.au

Customer Name: PEMBROOK HOMES UNIT-2

Site Address: 23 BELAIR AVENUE GLENROY

BENCH TOP: 20MM STONE
 BASE FINISH: SNOWDRIFT GLOSS
 O/HEAD FINISH:
 FEATURE #1 FINISH:
 FEATURE #2 FINISH:
 KICK FINISH:
 HINGE: Hettich Soft Close Hinge

BENCH TOP FINISH:
 BASE DOOR STYLE: Slab
 O/HEAD DOOR STYLE: Slab
 KICK HEIGHT:
 DRAWER RUNNER: DTC DragonPro Wte 40kg
 HANDLE: P-17 BLACK

Designed By: ERGUN

NOT TO SCALE

Design Date: 02/03/23

Page: 6 of 9

CLIENT SIGNATURE OF APPROVAL:

DATE:

DISCLAIMER: All designs *MUST* be signed & dated before production proceeds.



LAUNDRY

Classy Cabinets & Kitchens

QUALITY KITCHEN CABINETS & VANITY UNITS

Classy Cabinets & Kitchens

25 Gasoline Way
 Craigieburn. VIC 3064
 Ph: 9333 8411 Fax: 9333 8422
 E: quotes@classycabs.com.au

Customer Name: PEMBROOK HOMES UNIT-2

Site Address: 23 BELAIR AVENUE GLENROY

Designed By: ERGUN

NOT TO SCALE

Design Date: 02/03/23

Page: 7 of 9

REFER TO PLAN VIEW & ELEVATION VIEW FOR SPECIFICATIONS

CLIENT SIGNATURE OF APPROVAL:

DATE:

DISCLAIMER: All designs *MUST* be signed & dated before production proceeds.

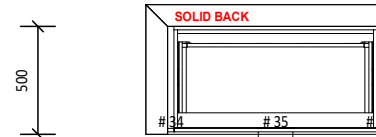
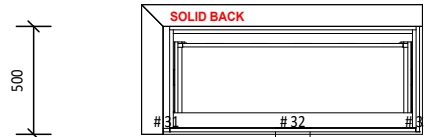
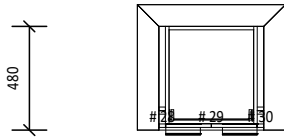
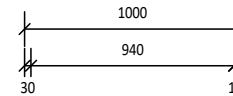
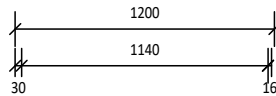
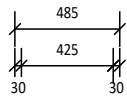

POWDER ROOM

BATHROOM

ENSUITE

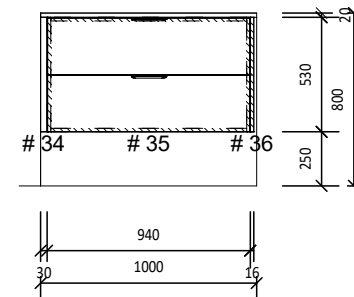
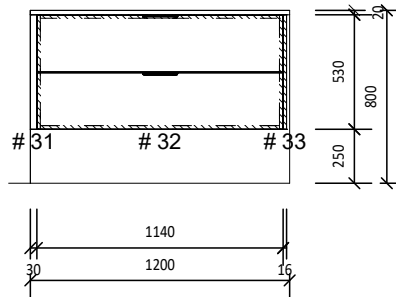
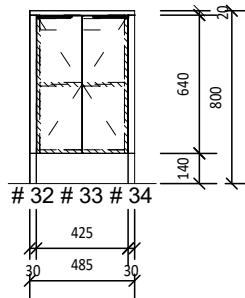

Classy Cabinets & Kitchens

QUALITY KITCHEN CABINETS & VANITY UNITS

Classy Cabinets & Kitchens

25 Gasoline Way
 Craigieburn. VIC 3064
 Ph: 9333 8411 Fax: 9333 8422
 E: quotes@classycabs.com.au

Customer Name: PEMBROOK HOMES UNIT-2

Site Address: 23 BELAIR AVENUE GLENROY

BENCH TOP: 20MM STONE
 BASE FINISH: NATURAL OAK MATT
 O/HEAD FINISH:
 FEATURE #1 FINISH:
 FEATURE #2 FINISH:
 KICK FINISH:
 HINGE: Hettich Soft Close Hinge

BENCH TOP FINISH:
 BASE DOOR STYLE: Slab
 O/HEAD DOOR STYLE: Slab
 KICK HEIGHT:
 DRAWER RUNNER: DTC DragonPro Wte 40kg
 HANDLE: P-17 BLACK

Designed By: ERGUN

NOT TO SCALE

Design Date: 02/03/23

Page: 8 of 9

CLIENT SIGNATURE OF APPROVAL:

DATE:

DISCLAIMER: All designs *MUST* be signed & dated before production proceeds.

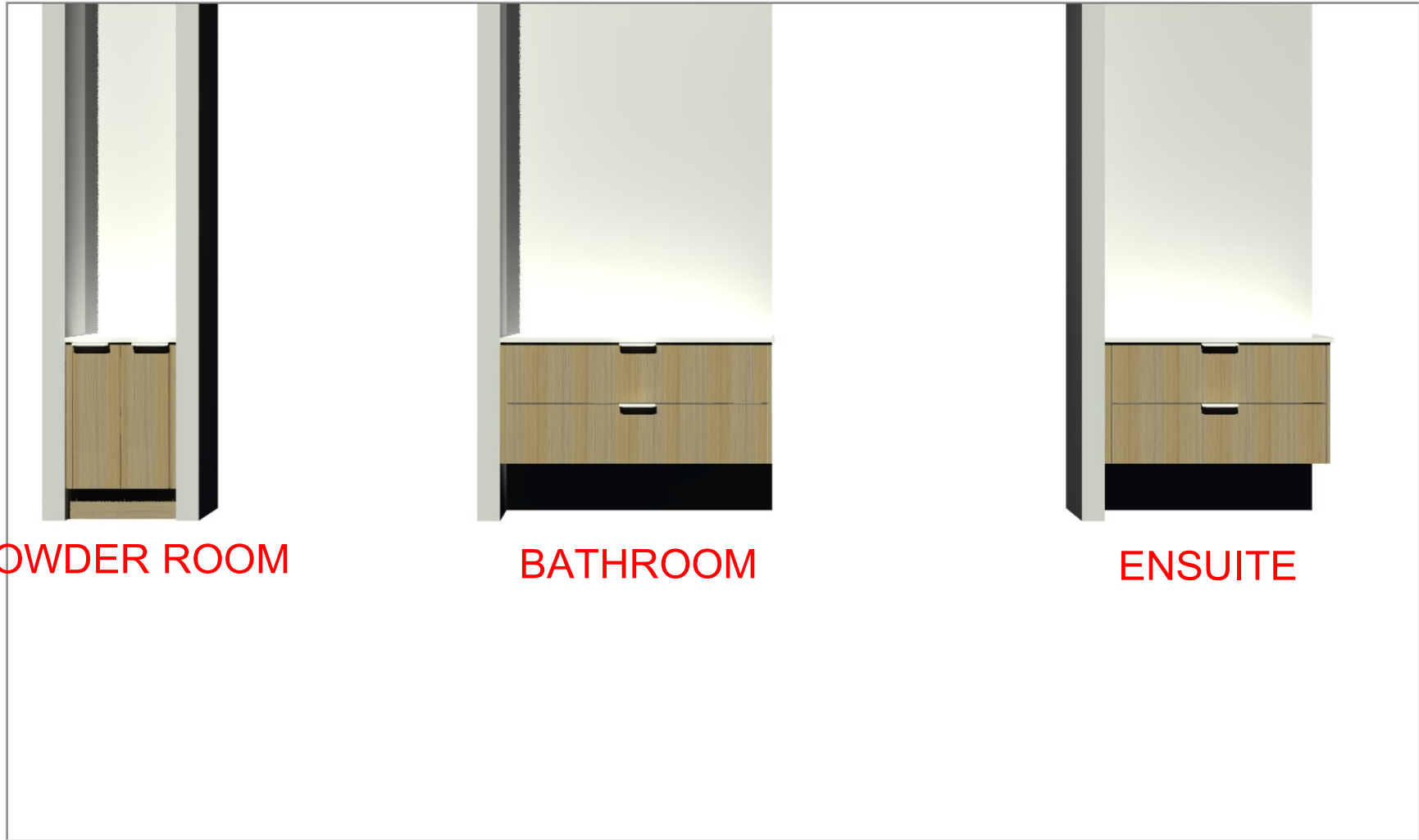

POWDER ROOM

BATHROOM

ENSUITE

Classy Cabinets & Kitchens

QUALITY KITCHEN CABINETS & VANITY UNITS

Classy Cabinets & Kitchens
 25 Gasoline Way
 Craigieburn. VIC 3064
 Ph: 9333 8411 Fax: 9333 8422
 E: quotes@classycabs.com.au

Customer Name: PEMBROOK HOMES UNIT-2

Site Address: 23 BELAIR AVENUE GLENROY

Designed By: ERGUN

NOT TO SCALE

Design Date: 02/03/23

Page: 9 of 9

REFER TO PLAN VIEW & ELEVATION VIEW FOR SPECIFICATIONS

CLIENT SIGNATURE OF APPROVAL:

DATE:

DISCLAIMER: All designs *MUST* be signed & dated before production proceeds.